

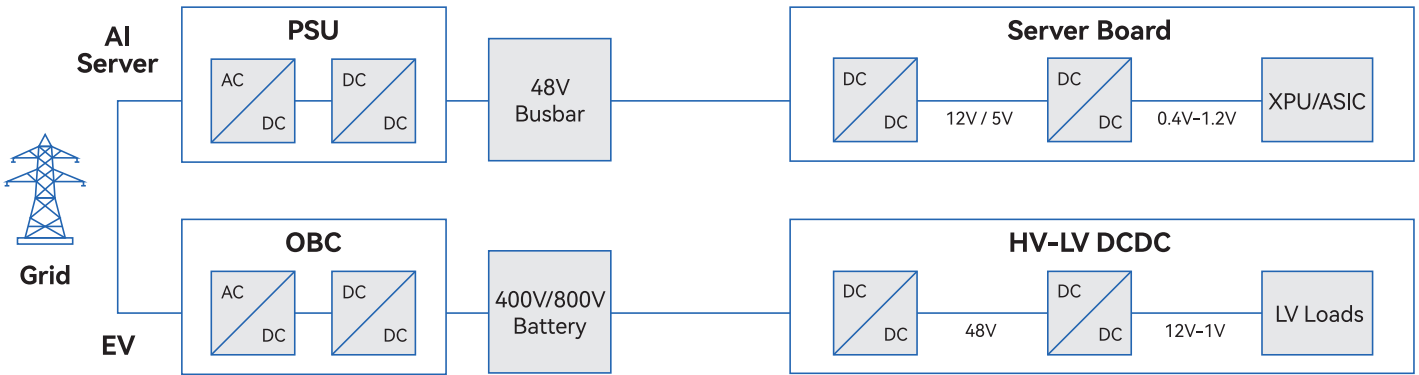

ThanTech

EMPOWERING SMART & GREEN FUTURE



ThanTech Product Series

PFC Inductor



Metal Powder Core



DC/DC Inductor



Metal Powder Core



Low Temp Molding

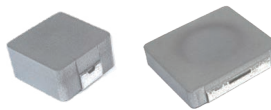

High Temp Molding

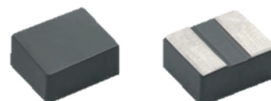

Single/Dual/Multi-phase



TLVR & Integrated



BETTER MATERIALS DEFINE BETTER COMPONENTS

Co-sintering Inductor

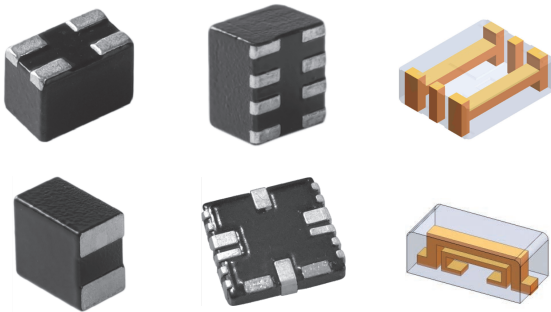

Molding Inductor

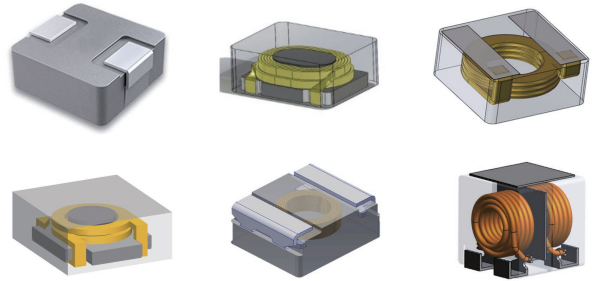

Packaging Integrated Inductor

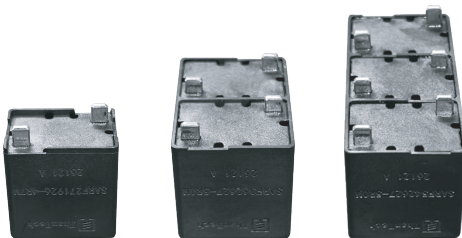

High-power Packaging Inductor



Magnetic Powder Core



Soft Magnetic Alloy Powder

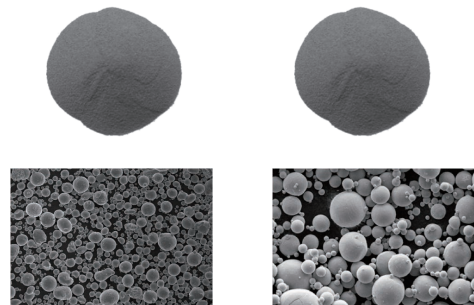

ThanTech, an inductor component supplier with material research and development technology, specializes in designing and manufacturing high-performance inductor components for applications in AI servers, optical modules, photovoltaics, automotive, and other fields. By enriching its material technology reserves and utilizing multiple manufacturing processes, ThanTech achieves inductor components with high power density, high efficiency, and high thermal conductivity.